

Verificator/ Expert	Nume/prenume	Referat/ Expertiza	nr./data
Verificator			2020
	Universitatea Tehnică "Gh. Asachi" din Iași Facultatea de Arhitectură "G. M. Cantacuzino" Centrul de cercetare Arhitectură și Urbanism Iași, Str. Str. Prof dr. doc. D. Mangeron Nr. 3, 700050	Centre de invatare Universitatea Tehnica "Gh. Asachi" Iasi Sala Facultatea de Inginerie Electrica, Energetica si Informatica aplicata	FAZA S.F.
		Beneficiar: UNIVERSITATEA TEHNICA "GH. ASACHI" DIN IASI	2/2020
Proiectat	arh. Mihai Codreanu	1:50	PLAN SALA E3 313 MOBILARE
Sef proiect	arh. Mihai Codreanu	februarie 2020	

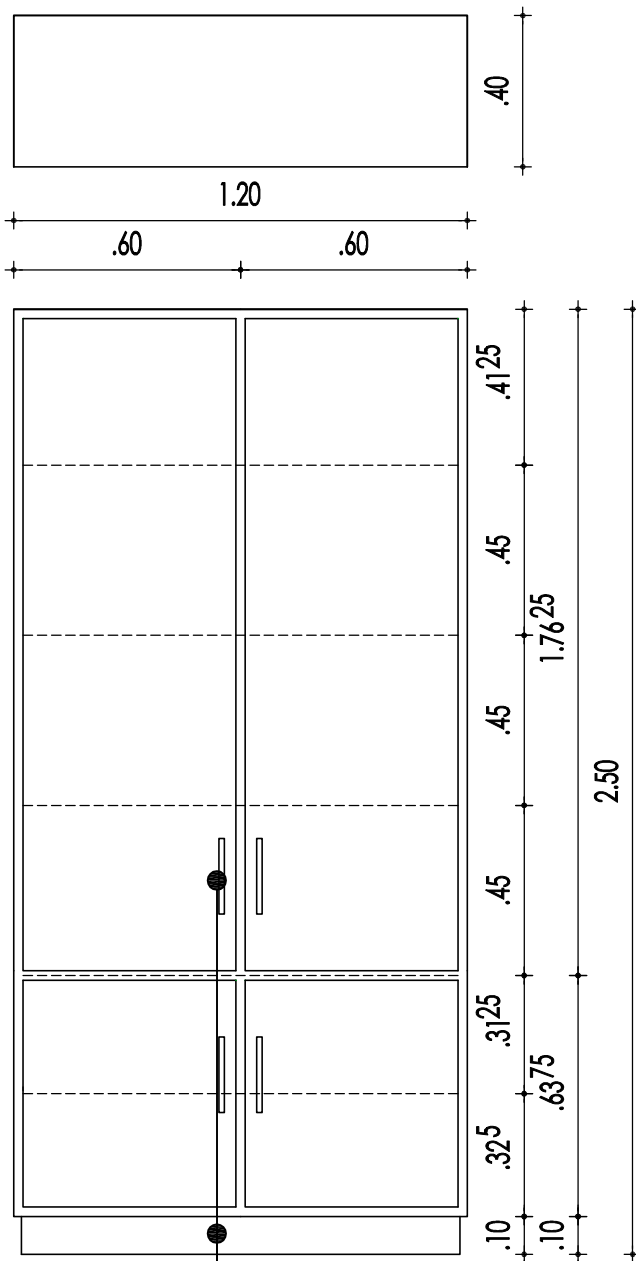

Verificator/ Expert	Nume/prenume	Referat/ Expertiza	nr./data
Verificator			2020
	Universitatea Tehnică "Gheorghe Asachi" din Iași Facultatea de Arhitectură și Urbanism Centrul de cercetare Arhitectură și Urbanism Iași, Str. Str. Prof dr. doc. D. Mangeron Nr. 3, 700050	Centre de invatare Universitatea Tehnica "Gh. Asachi" Iasi Sala Facultatea de Inginerie Electrica, Energetica si Informatica aplicata	FAZA S.F.
		Beneficiar: UNIVERSITATEA TEHNICA "GH. ASACHI" DIN IASI	2/2020
Proiectat	arh. Mihai Codreanu	PERSPECTIVE	A 14
Sef proiect	arh. Mihai Codreanu		



maner aluminiu satinat
 plinta PVC
 cu folie aluminiu satinat
 H = 10 mm

(M01) - Dulap inalt cu 4 usi, PAL melaminat gri, cu 4 rafturi

Verificator/ Expert	Nume/prenume	Cerinta	Referat/ Expertiza	nr./data
Verificator		A1		2020
	Universitatea Tehnică „Gheorghe Asachi” din Iasi Facultatea de Arhitectură „Gh. Asachi” Centrul de cercetare Arhitectură și Urbanism Iasi, Str. Str. Prof dr. doc. D. Mangeron Nr. 3, 700050		Centre de invatare Universitatea Tehnica "Gh. Asachi" Iasi	FAZA S.F.
			Beneficiar: UNIVERSITATEA TEHNICA "GH. ASACHI" DIN IASI	2/2020
		1:20	TABEL MOBILIER	DA 1
Proiectat	arh. Mihai Codreanu	februarie		
Sef proiect	arh. Mihai Codreanu	2020		

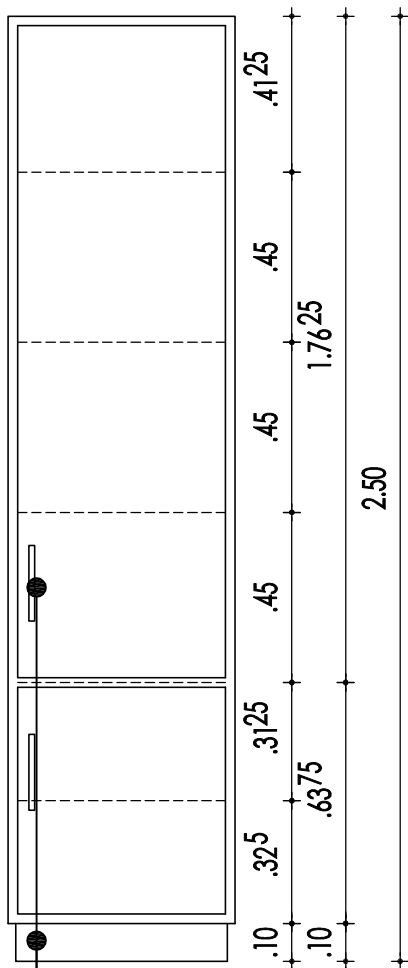
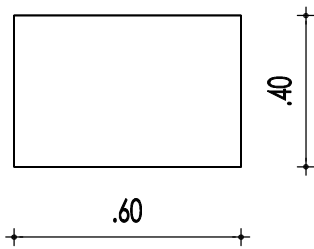

maner aluminiu satinat
 plinta PVC
 cu folie aluminiu satinat
 H = 10 mm

(M02) - Dulap inalt cu 2 usi, Pal melaminat gri, cu 4 rafturi

Verificator/ Expert	Nume/prenume	Cerinta	Referat/ Expertiza	nr./data
Verificator		A1		2020
	Universitatea Tehnică „Gheorghe Asachi” din Iasi Facultatea de Arhitectură „G.M. Cantacuzino” Centrul de cercetare Arhitectură și Urbanism Iasi, Str. Str. Prof dr. doc. D. Mangeron Nr. 3, 700050	1:20	Centre de invatare Universitatea Tehnica "Gh. Asachi" Iasi	FAZA S.F.
			Beneficiar: UNIVERSITATEA TEHNICA "GH. ASACHI" DIN IASI	2/2020
Proiectat	arh. Mihai Codreanu	februarie	TABEL MOBILIER	DA 2
Sef proiect	arh. Mihai Codreanu	2020		

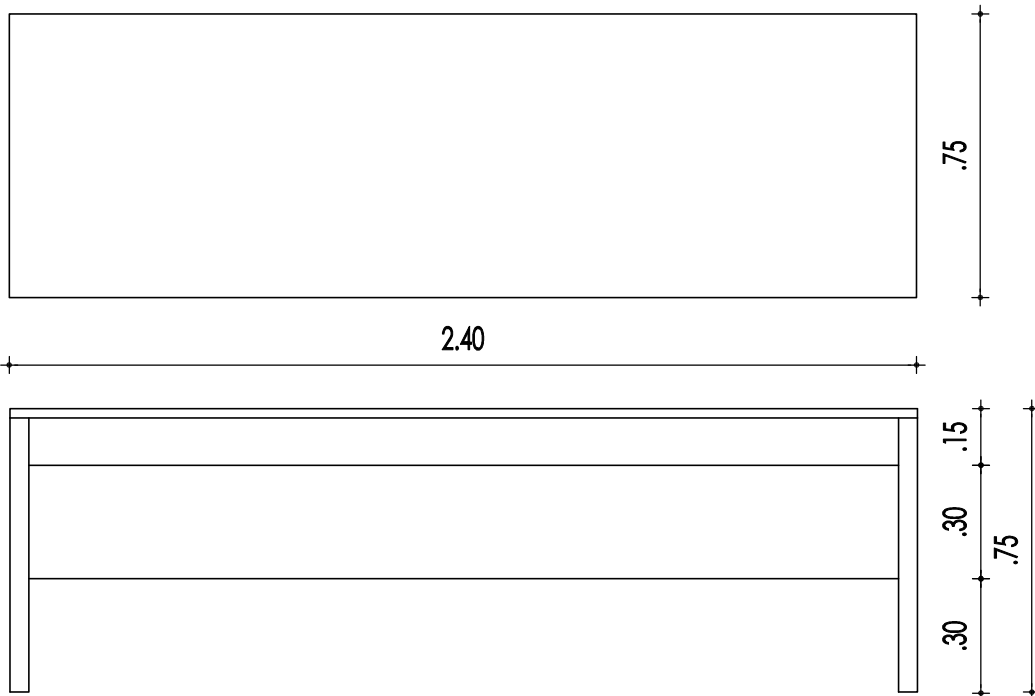
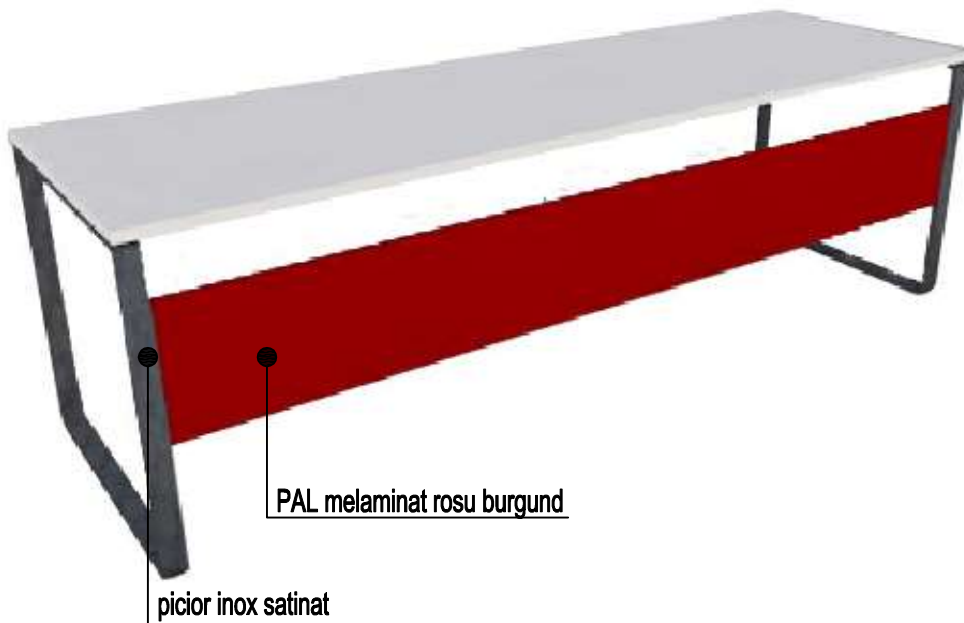

M03 - Birou 240x75 , blat PAL melaminat gri 40 mm

Verificator/ Expert	Nume/prenume	Cerinta	Referat/ Expertiza	nr./data
Verificator		A1		2020
	Universitatea Tehnică „Gheorghe Asachi” din Iasi Facultatea de Arhitectură „Gheorghe Asachi” Centrul de cercetare Arhitectură și Urbanism Iasi, Str. Str. Prof dr. doc. D. Mangeron Nr. 3, 700050		Centre de invatare Universitatea Tehnica "Gh. Asachi" Iasi	FAZA S.F.
			Beneficiar: UNIVERSITATEA TEHNICA "GH. ASACHI" DIN IASI	2/2020
		1:20	TABEL MOBILIER	DA 3
Proiectat	arh. Mihai Codreanu	februarie		
Sef proiect	arh. Mihai Codreanu	2020		



PAL melaminat rosu burgund



textil rosu burgund

picior inox satinat

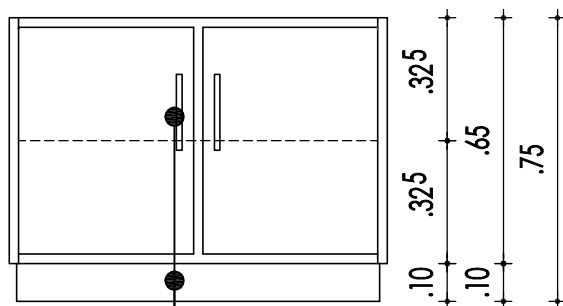
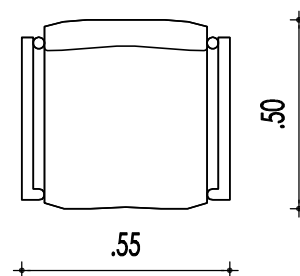
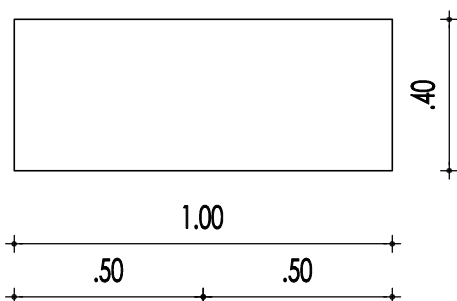

maner aluminiu satinat
plinta PVC
cu folie aluminiu satinat
H = 10 mm

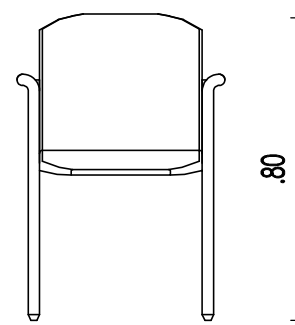

M04

- Dulap jos cu 2 usi, PAL melaminat gri,
cu 2 rafturi

M05

- Scaun birou

Verificator/ Expert	Nume/prenume	Cerinta	Referat/ Expertiza	nr./data
Verificator		A1		2020
	Universitatea Tehnică „Gheorghe Asachi” din Iasi Facultatea de Arhitectură „Gheorghe Asachi” Centrul de cercetare Arhitectură și Urbanism Iasi, Str. Prof dr. doc. D. Mangeron Nr. 3, 700050		Centre de invatare Universitatea Tehnica "Gh. Asachi" Iasi	FAZA S.F.
			Beneficiar: UNIVERSITATEA TEHNICA "GH. ASACHI" DIN IASI	2/2020
Proiectat	arh. Mihai Codreanu	1:20	TABEL MOBILIER VARAINTA 1	DA 4
Sef proiect	arh. Mihai Codreanu	februarie 2020		



PAL melaminat rosu burgund

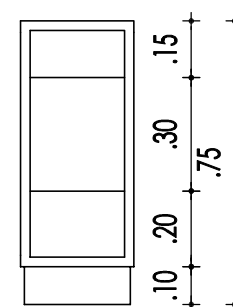
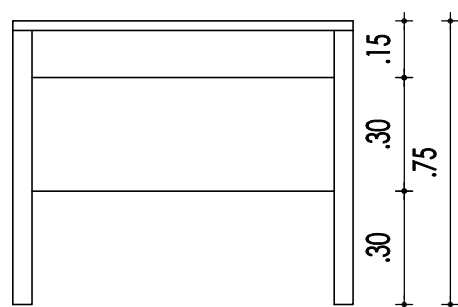
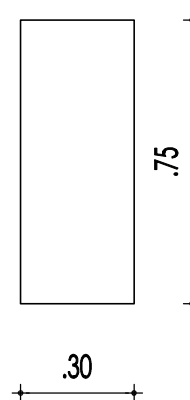
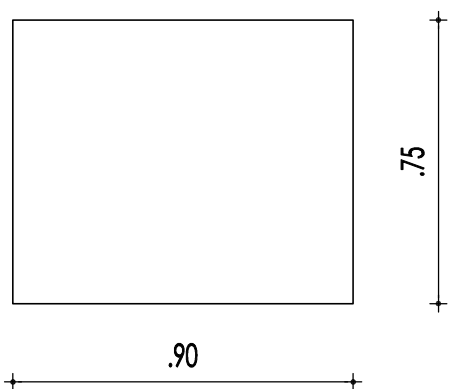

M06 - Birou 90x75,
blat de PAL melaminat gri 40 mm

M07 - Etajera unitate PC,
PAL melaminat rosu burgund

Verificator/ Expert	Nume/prenume	Cerinta	Referat/ Expertiza	nr./data
Verificator		A1		2020
	Universitatea Tehnică „Gheorghe Asachi” din Iasi Facultatea de Arhitectură „Gheorghe Asachi” Centrul de cercetare Arhitectură și Urbanism Iasi, Str. Str. Prof dr. doc. D. Mangeron Nr. 3, 700050		Centre de invatare Universitatea Tehnica "Gh. Asachi" Iasi	FAZA S.F.
			Beneficiar: UNIVERSITATEA TEHNICA "GH. ASACHI" DIN IASI	2/2020
		1:20	TABEL MOBILIER	DA 5
Proiectat	arh. Mihai Codreanu	februarie		
Sef proiect	arh. Mihai Codreanu	2020		